

HZE05

Air Treatment Units

New size 05 (50 mm)

Standard configurations:

- Filter
- Regulator
- Lubricator
- Filter regulator (FR)
- Filter regulator + Lubricator (FR+L)
- Filter + Regulator + Lubricator (F+R+L)

ATEX version available upon request:

CE II 3 GD c nA II T5 -10 °C ≤ Ta ≤ 45 °C



TECHNICAL CHARACTERISTICS

Ambient temperature	0 ÷ 60 °C
Fluid	compressed filtered air, with or without lubrication
Working pressure	10 bar
Max pressure	15 bar

CONSTRUCTIVE CHARACTERISTICS

Body	die-cast aluminium (painted)
Knob	technopolymer
Ring nut	technopolymer
Bowl	polycarbonate
Bowl guard	technopolymer
Filter element	polyethylene
Seals	nitrile rubber (NBR)
Springs	steel
Diaphragm	fabric reinforced rubber

CODIFICATION KEY

H	Z	E	0	5	B	0	8	G		M	
1	2	3	4	5	6	7					

1 Series	2 Size	3 Model
HZE Air treatment units with standard manual drain	05 = (G1/4 - G3/8)	F = Filter R = Regulator L = Lubricator B = Filter regulator (FR) D = Filter regulator + Lubricator (FR+L) C = Filter + Regulator + Lubricator (F+R+L)
4 Thread	5 Option	6 Pressure gauge
08G = G1/4" 10G = G3/8"	S = Semi-automatic drain	M = Integrated square pressure gauge (standard supplied)
7 ATEX option	X = Atex (upon request)	

Flow characteristics

Filter

>> Supply pressure
7 bar

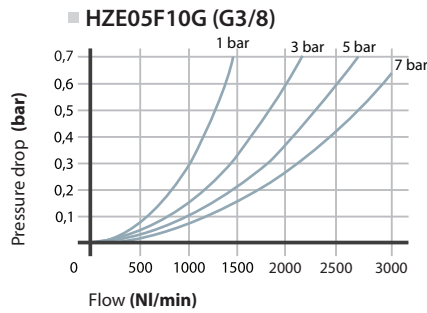
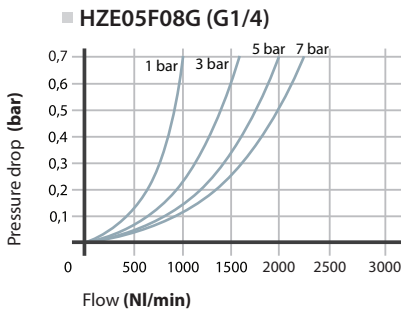

Regulator

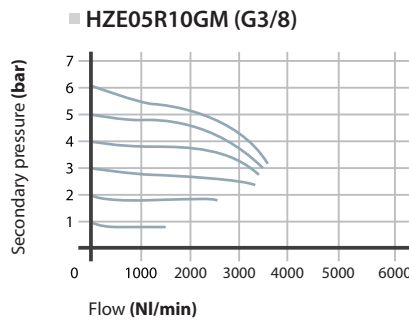
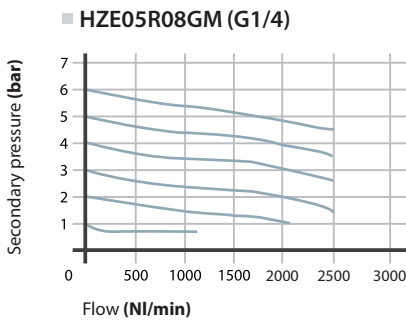

Lubricator

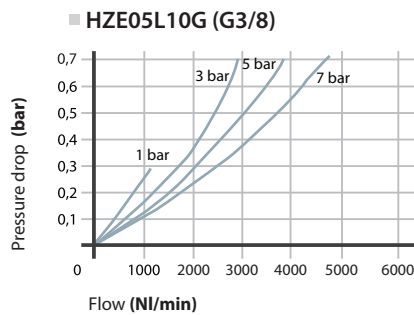
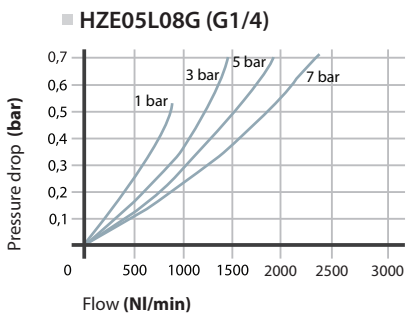

Filter regulator

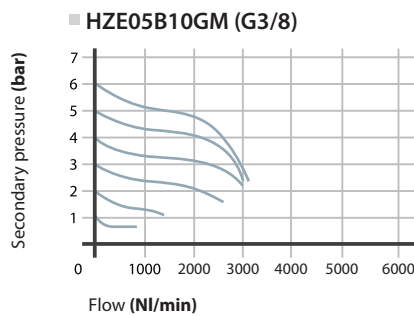
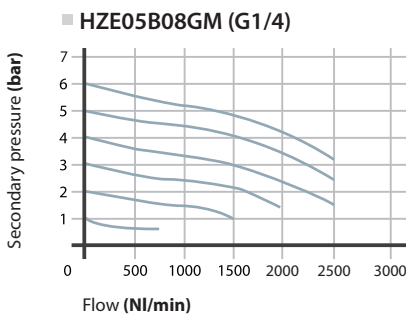

Filter regulator + Lubricator

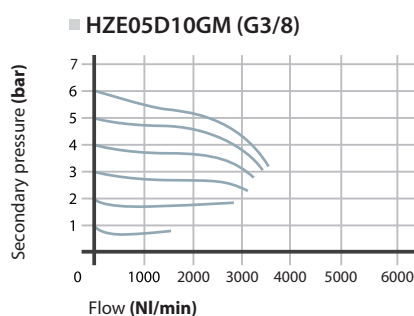
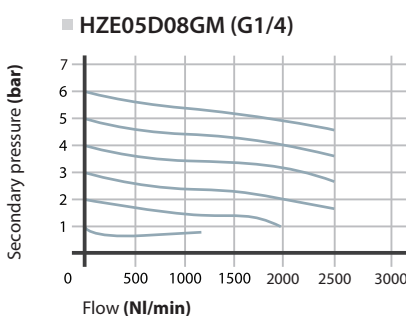

4

B - Filter regulator

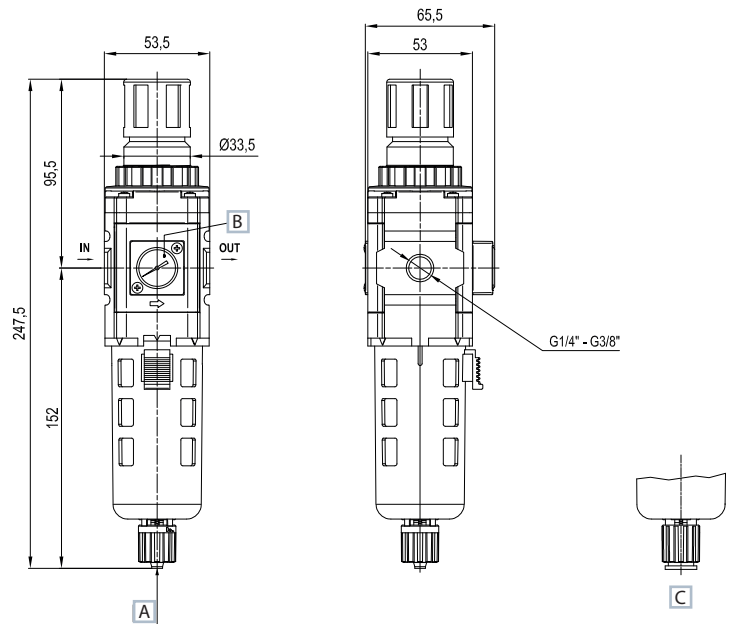
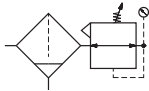

- A** Manual drain ID Tube 5,5 mm
- B** Pressure gauge **HZ9464G** standard supplied
- C** Semi-automatic drain OD Tube 8 mm

Part No.	HZE05B08GM	HZE05B10GM
Connections	G1/4	G3/8
Filtration rate (µm)	5	
Flow rate NI/min ^(A)	1500	2000
Max inlet pressure (bar-MPa-psi)	10 - 1 - 145	
Pressure adjustment-relieving version (bar)	0,5 ÷ 8,5	
Pressure gauge (standard supplied)	HZ9464G	
Pressure gauge adaptor	G1/8 ^(B)	
Fluid	compressed air	
Ambient temperature (°C)	0 ÷ 60	
Condensation drain capacity (cm ³)	40	
Condensation drain	manual	
Weight (Kg)	0,41	
Mounting position	vertical	

(A) = inlet pressure 7 bar, outlet pressure 5 bar - Δp 1 bar

(B) = upon request (replace HZ9464G gauge with HZE7Z480 square adaptor G1/8, to be ordered separately)